

iDS-2CD7A26G0/P-IZHS(Y) 2 MP ANPR IR Varifocal Bullet Network Camera

DarkFighter



▪ DeepinView^{series}

- High quality imaging with 2 MP resolution
- Excellent low-light performance via DarkFighter technology
- Clear imaging against strong back light due to 140 dB WDR technology
- License Plate Recognition
- Efficient H.265+ compression technology to save bandwidth and storage
- 5 streams to meet a wide variety of applications
- Water and dust resistant (IP67) and vandal proof (IK10)



▪ **Function**

Road Traffic and Vehicle Detection

With embedded deep learning based license plate capture and recognition algorithms, the camera alone can achieve plate capture and recognition. The algorithm enjoys the high recognition accuracy of common plates and complex-structured plates, which is a great step forward comparing to traditional algorithms. Blocklist and allowlist are available for plate categorization and separate alarm triggering.

▪ Specification

| Camera | |
|-----------------------------|--|
| Image Sensor | 1/1.8" Progressive Scan CMOS |
| Max. Resolution | 1920 × 1080 |
| Min. Illumination | Color: 0.0005 Lux @ (F1.2, AGC ON); B/W: 0.0001 Lux @ (F1.2, AGC ON) , 0 Lux with IR |
| Shutter Time | 1 s to 1/100,000 s |
| Day & Night | IR cut filter Blue glass module to reduce ghost phenomenon |
| Lens | |
| Focal Length & FOV | 2.8 to 12 mm, horizontal FOV: 114.5° to 41.8°, vertical FOV: 59.3° to 23.6°, diagonal FOV: 141.1° to 48° 8 to 32 mm, horizontal FOV: 42.5° to 15.1°, vertical FOV: 23.3° to 8.64°, diagonal FOV: 49.6° to 17.3° |
| Focus | Auto, semi-auto, manual |
| Iris Type | P-iris |
| Aperture | 2.8 to 12 mm: F1.2 to F2.5 8 to 32 mm: F1.7 to F1.73 |
| Illuminator | |
| Supplement Light Type | IR |
| Supplement Light Range | 2.8 to 12 mm: 50 m 8 to 32 mm: 100 m |
| Smart Supplement Light | Yes |
| IR Wavelength | 850 nm |
| Video | |
| Main Stream | 50 Hz: 25 fps (1920 × 1080, 1280 × 720) 60 Hz: 30 fps (1920 × 1080, 1280 × 720) |
| Sub-Stream | 50 Hz: 25 fps (704 × 576, 640 × 480) 60 Hz: 30 fps (704 × 480, 640 × 480) |
| Third Stream | 50 Hz: 25 fps (1920 × 1080, 1280 × 720, 704 × 576, 640 × 480) 60 Hz: 30 fps (1920 × 1080, 1280 × 720, 704 × 480, 640 × 480) |
| Fourth Stream | 50 Hz: 25 fps (1920 × 1080, 1280 × 720, 704 × 576, 640 × 480) 60 Hz: 30 fps (1920 × 1080, 1280 × 720, 704 × 480, 640 × 480) |
| Fifth Stream | 50 Hz: 25 fps (704 × 576, 640 × 480) 60 Hz: 30 fps (704 × 480, 640 × 480) |
| Video Compression | Main stream: H.265+/H.265/H.264+/H.264 Sub-stream/Third stream/Fourth stream/Fifth stream: H.265/H.264/MJPEG |
| Video Bit Rate | 32 Kbps to 8 Mbps |
| H.264 Type | Baseline Profile/Main Profile/High Profile |
| H.265 Type | Main Profile |
| Bit Rate Control | CBR/VBR |
| Scalable Video Coding (SVC) | H.265 and H.264 encoding |
| Region of Interest (ROI) | 4 fixed regions for each stream |
| Target Cropping | Yes |

| Audio | |
|-----------------------------|--|
| Audio Type | Mono sound |
| Audio Compression | G.711/G.722.1/G.726/MP2L2/PCM/AAC/MP3 |
| Audio Bit Rate | 64 Kbps (G.711)/16 Kbps (G.722.1)/16 Kbps (G.726)/32 to 192 Kbps (MP2L2)/16 to 64 Kbps (AAC)/8 to 320 Kbps (MP3) |
| Audio Sampling Rate | 8 kHz/16 kHz/32 kHz/44.1 kHz/48 kHz |
| Environment Noise Filtering | Yes |
| Network | |
| Protocols | TCP/IP, ICMP, HTTP, HTTPS, FTP, SFTP, SRTP, DHCP, DNS, DDNS, RTP, RTSP, RTCP, PPPoE, NTP, UPnP, SMTP, SNMP, IGMP, 802.1X, QoS, IPv6, UDP, Bonjour, SSL/TLS |
| Simultaneous Live View | Up to 20 channels |
| API | Open Network Video Interface (PROFILE S, PROFILE G, PROFILE T), ISAPI, SDK, ISUP |
| User/Host | Up to 32 users. 3 user levels: administrator, operator and user |
| Security | Password protection, complicated password, HTTPS encryption, 802.1X authentication (EAP-TLS, EAP-LEAP, EAP-MD5), watermark, IP address filter, basic and digest authentication for HTTP/HTTPS, WSSE and digest authentication for Open Network Video Interface, RTP/RTSP OVER HTTPS, Control Timeout Settings, Security Audit Log, TLS 1.2 |
| Network Storage | NAS (NFS, SMB/CIFS), auto network replenishment (ANR) Together with high-end Hikvision memory card, memory card encryption and health detection are supported |
| Client | iVMS-4200, Hik-Connect, Hik-Central |
| Web Browser | Plug-in required live view: IE8+ Plug-in free live view: Chrome 57.0+, Firefox 52.0+, Safari 11+ Local service: Chrome 41.0+, Firefox 30.0+ |
| Image | |
| Image Parameters Switch | Yes |
| Image Settings | Saturation, brightness, contrast, sharpness, gain, white balance adjustable by client software or web browser |
| Day/Night Switch | Day, Night, Auto, Schedule, Alarm Trigger, Video Trigger |
| Wide Dynamic Range (WDR) | 140 dB |
| SNR | ≥ 52 dB |
| Image Enhancement | BLC, HLC, Defog, 3D DNR |
| Picture Overlay | LOGO picture can be overlaid on video with 128 × 128 24bit bmp format |
| Image Stabilization | EIS |
| Interface | |
| Video Output | 1 Vp-p Composite Output (75 Ω/CVBS) (Only for debugging) |
| Ethernet Interface | 1 RJ45 10 M/100 M/1000 M self-adaptive Ethernet port |
| On-Board Storage | Built-in memory card slot, support microSD/microSDHC/microSDXC card, up to 256 GB |
| Audio | With -Y: 1 input (line in), 1 output (line out), 3.5 mm connector |
| Alarm | 2 input, 2 outputs (max. 24 VDC, 1 A) |
| RS-485 | With -Y: 1 RS-485 (half duplex, HIKVISION, Pelco-P, Pelco-D, self-adaptive) |
| Reset Key | Yes |
| Power Output | With -Y: 12 VDC, max. 100 mA |
| Wiegand | /P-Y: 1 Wiegand (CardID 26bit, SHA-1 26bit, Hik 34bit, NEWG 72bit) |

| Event | |
|------------------------------------|---|
| Basic Event | Motion detection, video tampering alarm, exception (network disconnected, IP address conflict, illegal login, abnormal reboot, HDD full, HDD error), video quality diagnosis, vibration detection |
| Smart Event | Intrusion detection, scene change detection, audio exception detection, defocus detection Line crossing detection, up to 4 lines configurable Intrusion detection, up to 4 regions configurable Region entrance detection, up to 4 regions configurable Region exiting detection, up to 4 regions configurable |
| Linkage | Upload to FTP/NAS/memory card, notify surveillance center, send email, trigger alarm output, trigger recording, trigger capture |
| Deep Learning Function | |
| Perimeter Protection | Line crossing, intrusion, region entrance, region exiting Support alarm triggering by specified target types |
| Road Traffic and Vehicle Detection | Blocklist and allowlist: up to 10,000 records Captures vehicle that has no license plate Support license plate recognition of motorcycles (only in checkpoint scenario) Support vehicle attribute detection, including vehicle type, color, brand, etc. (City Street mode is recommended.) |
| Metadata | Metadata of road traffic is supported. |
| General | |
| Power | 12 VDC \pm 20%, 1.19 A, max. 14.28 W, three-core terminal block PoE: 802.3at, Type 2, Class 4, 42.5 V to 57 V), 0.396 A to 0.295 A, max. 16.8 W |
| Material | Aluminum alloy body |
| Dimension | Without -Y: \varnothing 144 \times 347 mm (\varnothing 5.7" \times 13.7") With -Y: \varnothing 140 \times 351 mm (\varnothing 5.5" \times 13.8") |
| Package Dimension | 405 \times 190 \times 180 mm (15.9" \times 7.5" \times 7.1") |
| Weight | Approx. 1950 g (4.2 lb.) |
| With Package Weight | Approx. 3070 g (6.7 lb.) |
| Storage Conditions | -30 $^{\circ}$ C to 60 $^{\circ}$ C (-22 $^{\circ}$ F to 140 $^{\circ}$ F). Humidity 95% or less (non-condensing) |
| Startup and Operating Conditions | -40 $^{\circ}$ C to 60 $^{\circ}$ C (-40 $^{\circ}$ F to 140 $^{\circ}$ F). Humidity 95% or less (non-condensing) |
| Language | 33 languages: English, Russian, Estonian, Bulgarian, Hungarian, Greek, German, Italian, Czech, Slovak, French, Polish, Dutch, Portuguese, Spanish, Romanian, Danish, Swedish, Norwegian, Finnish, Croatian, Slovenian, Serbian, Turkish, Korean, Traditional Chinese, Thai, Vietnamese, Japanese, Latvian, Lithuanian, Portuguese (Brazil), Ukrainian |
| General Function | Anti-flicker, 5 streams, EPTZ, heartbeat, mirror, privacy mask, flash log, password reset via email, pixel counter |
| Heater | Yes |

Approval

| | |
|---------------------------|---|
| EMC | FCC (47 CFR Part 15, Subpart B); CE-EMC (EN 55032: 2015, EN 61000-3-2:2019, EEN 61000-3-3:2013+A1:2019, EN 50130-4: 2011 +A1: 2014); RCM (AS/NZS CISPR 32: 2015); IC (ICES-003: Issue 7); KC (KN 32: 2015, KN 35: 2015) |
| Safety | UL (UL 62368-1); CB (IEC 62368-1:2014+A11); CE-LVD (EN 62368-1:2014/A11:2017); BIS (IS 13252(Part 1):2010/ IEC 60950-1 : 2005); LOA (IEC/EN 60950-1) |
| Environment | CE-RoHS (2011/65/EU); WEEE (2012/19/EU); Reach (Regulation (EC) No 1907/2006) |
| Protection | IK10 (IEC 62262:2002), IP67 (IEC 60529-2013) |
| Anti-Corrosion Protection | With -Y: NEMA 4X(NEMA 250-2018) |
| Automotive and Railway | EN50121-4 |
| Other | PVC FREE |

▪ Available Model

iDS-2CD7A26G0/P-IZHSY (2.8 to 12 mm, 8 to 32 mm)

iDS-2CD7A26G0/P-IZHS (2.8 to 12 mm, 8 to 32 mm)

▪ **Dimension**

-Y model:

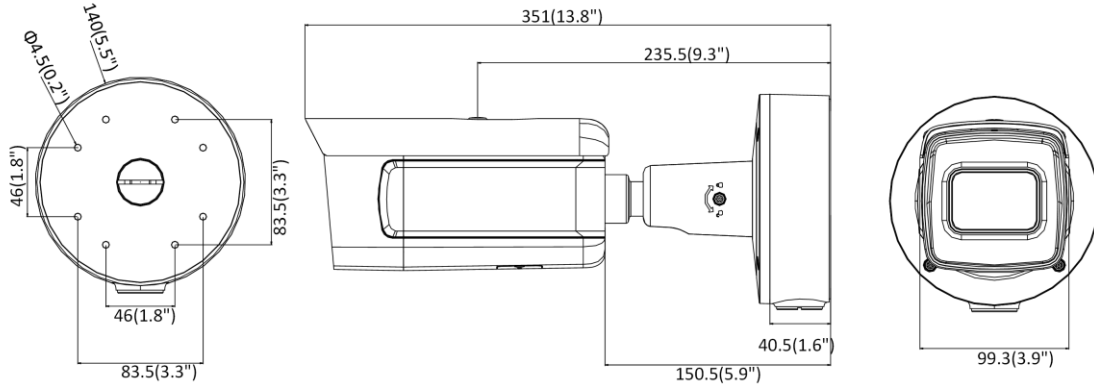



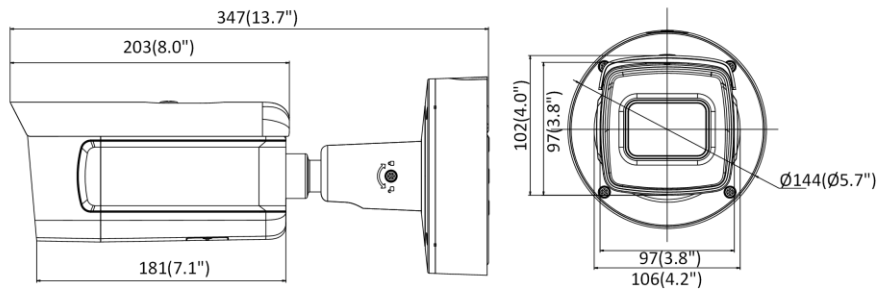

Without -Y model:



Unit: mm(inch)

▪ **Accessory**

▪ **Optional**

| DS-1475ZJ-Y Vertical Pole Mount | DS-1475ZJ-SUS Vertical Pole Mount | DS-2251ZJ Pendant Mount | DS-1476ZJ-Y Corner Mount | DS-1476ZJ-SUS Corner Mount |
|---|---|---|---|---|
|  |  |  |  |  |

Distributed by

**HIKVISION®****Headquarters**

No.555 Qianmo Road, Binjiang District,
Hangzhou 310051, China
T +86-571-8807-5998
overseasbusiness@hikvision.com

Hikvision USA
T +1-909-895-0400
sales.usa@hikvision.com

Hikvision Australia
T +61-2-8599-4233
salesau@hikvision.com

Hikvision India
T +91-22-28469900
sales@pramahikvision.com

Hikvision Canada
T +1-866-200-6690
sales.canada@hikvision.com

Hikvision Thailand
T +662-275-9949
sales.thailand@hikvision.com

Hikvision Europe
T +31-23-5542770
sales.eu@hikvision.com

Hikvision Italy
T +39-0438-6902
info.it@hikvision.com

Hikvision Brazil
T +55 11 3318-0050
Latam.support@hikvision.com

Hikvision Turkey
T +90 (216)521 7070- 7074
sales.tr@hikvision.com

Hikvision Malaysia
T +601-7652-2413
sales.my@hikvision.com

Hikvision UK & Ireland
T +01628-902140
sales.uk@hikvision.com

Hikvision South Africa
Tel: +27 (10) 0351172
sale.africa@hikvision.com

Hikvision France
T +33(0)1-85-330-450
info.fr@hikvision.com

Hikvision Kazakhstan
T +7-727-9730667
nikia.panfilov@hikvision.ru

Hikvision Vietnam
T +84-974270888
sales.vt@hikvision.com

Hikvision UAE
T +971-4-4432090
salesme@hikvision.com

Hikvision Singapore
T +65-6684-4718
sg@hikvision.com

Hikvision Spain
T +34-91-737-16-55
info.es@hikvision.com

Hikvision Tashkent
T +99-87-1238-9438
uzb@hikvision.ru

Hikvision Hong Kong
T +852-2151-1761
info.hk@hikvision.com

Hikvision Russia
T +7-495-669-67-99
saleru@hikvision.com

Hikvision Korea
T +82-(0)31-731-8817
sales.korea@hikvision.com

Hikvision Poland
T +48-22-460-01-50
info.pl@hikvision.com

Hikvision Indonesia
T +62-21-2933759
Sales.Indonesia@hikvision.com

Hikvision Colombia
sales.colombia@hikvision.com